



Owner's Manual

Original Instructions

G-Cloud

Model:

ME31-00/C4

ME31-00/C6

Thank you for choosing this product. Please read this Owner's Manual carefully before operation and retain it for future reference. If you have lost the Owner's Manual, please contact the local agent or visit www.gree.com or send an email to global@gree.com.cn for the electronic version.

GREE ELECTRIC APPLIANCES, INC. OF ZHUHAI

To Users

Thank you for selecting Gree products. For correct installation and operations, please read this manual carefully and be aware of the following items:

- (1) This appliance is not intended for use by persons (including children) with reduced physical, sensory or mental capabilities, or lack of experience and knowledge, unless they have been given supervision or instruction concerning use of the appliance by a person responsible for their safety.
- (2) All graphics and information in this manual are only for reference. As for the control panel, please refer to the products.
- (3) In order to make the products better, we will continuously conduct improvement and innovation. We have the right to make necessary revision to the products from time to time due to the reason of sales or production, and reserve the right to revise the contents without further notice.
- (4) Gree will not take responsible for any personal injury, property loss and device damage, etc. caused by improper installation and debugging, unnecessary maintenance, infringing related national laws and regulations and industry standard, or violating any regulation in this manual.
- (5) Gree reserves the final rights to interpret this manual.

Contents

1 SKETCH MAP	1
2 ACCESSORIES LIST	2
3 INSTALLATION	3
4 APP INSTRUCTIONS.....	10



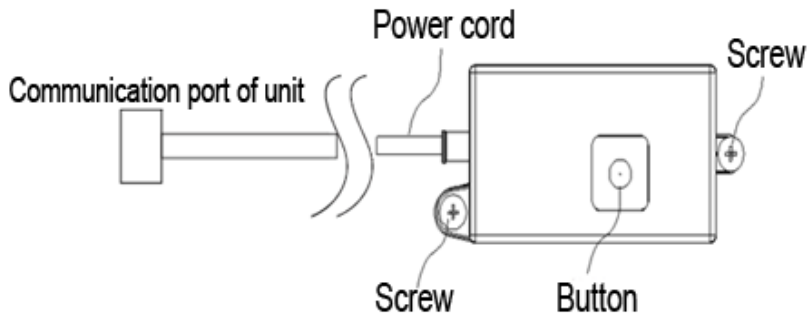

1 Sketch Map



When G-Cloud is matched with smart phones, GREE + App and wireless router for operation, it can realize remote monitoring, schedule management, scene management, temperature setting and other functions of air conditioner.

2 Accessories List

ME31-00/C4、ME31-00/C6:

Name	Photo	Q'ty	Unit	Purpose
Tapping screw(longer)		2	pieces	Fixing G-Cloud
Tapping screw		2	pieces	Fixing G-Cloud
Plastic expansion pipe		2	pieces	Fixing the tapping screw
High-temperature tieline		3	pieces	Fixing the wires

Note:

- ①For duct-type unit, please fix the G-Cloud with longer tapping screws.
- ②For floor ceiling unit, please fix the G-Cloud with normal tapping screws.
- ③For cassette type unit, please fix the G-Cloud with tapping screws based on the models of cassette type unit.

3 Installation

Note:

- ① G-Cloud can be connected to any supporting indoor unit for installation.
- ② please install the G-Cloud at the indoor position where there's the strongest WiFi signal, and try to close to indoor routers as much as possible.
- ③ G-Cloud ME31-00/C4 is only available for some certain models cassette type unit, and G-Cloud ME31-00/C6 is available for duct-type unit, floor ceiling unit and the remaining models cassette type unit.
- ④ For model GUD35T/A-T and GUD50T/A-T, please use the G-Cloud ME31-00/C6; for models GUD71T/A-T, GUD85T/A-T, GUD100T/A-T, GUD125T/A-T, GUD140T/A-T and GUD160T/A-T, please use the G-Cloud ME31-00/C4.

3.1 Installation procedure of G-cloud ME31-00/C4:

Note: G-Cloud ME31-00/C4 is only available for cassette type unit with models GUD71T/A-T, GUD85T/A-T, GUD100T/A-T, GUD125T/A-T, GUD140T/A-T and GUD160T/A-T.

1. Lead the communication port of G-Cloud from the wire outlet of electric box, and then connect the communication port of G-Cloud unit to the corresponding communication port on the main board of the indoor unit;

2. Fix the G-Cloud to the certain position (fix it with normal tapping screws).

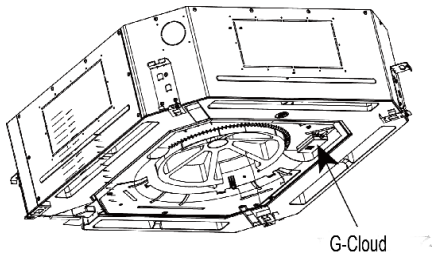

3.2 Installation procedure of G-Cloud ME31-00/C6

Note: G-Cloud ME31-00/C6 is available for cassette type unit with models GUD35T/A-T and GUD50T/A-T.

3.2.1 G-Cloud installation for cassette type unit:

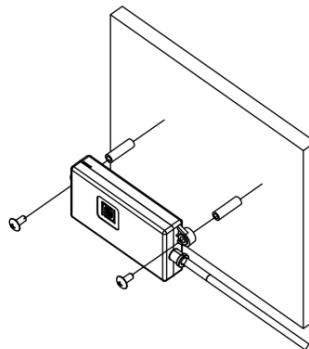
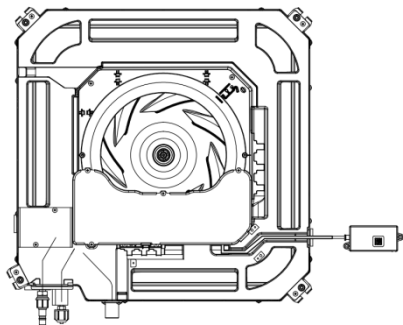

1. Connect the communication port of G-Cloud unit to the corresponding communication port on the main board of the indoor unit;
2. Fix the G-Cloud to a certain position on the wall (fix it with longer tapping screws).

3.2.2 G-Cloud installation for duct-type unit:

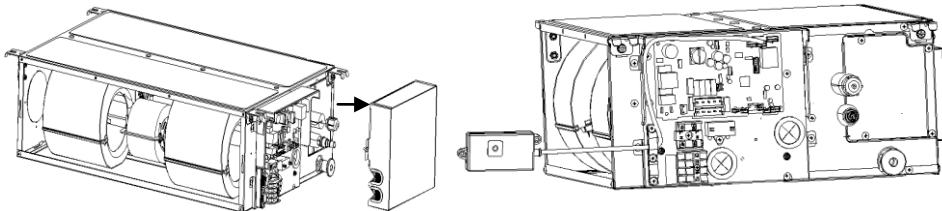

1. Open the electric box of indoor unit;

2. Lead the communication port of G-Cloud from the wire outlet of electric box, and then connect the communication port of G-Cloud unit to the corresponding communication port on the main board of the indoor unit;

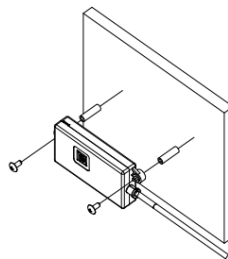
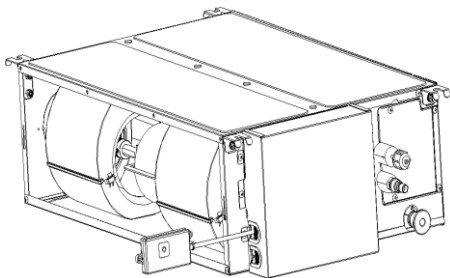

3. When connection is succeeded, close the electric box;

4. Fix the G-Cloud to a certain position on the wall (fix it with longer tapping screws).

3.2.3 G-Cloud installation for floor ceiling unit:

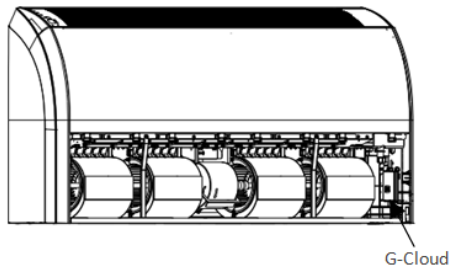
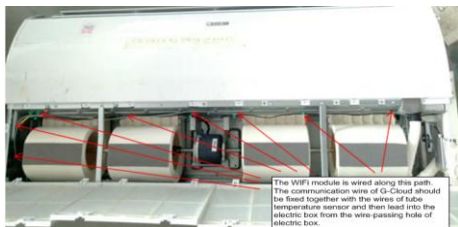

1. The communication wire of G-Cloud should be fixed together with the wires of tube temperature sensor and then lead into the electric box from the wire-passing hole of electric box;
2. Fix the G-Cloud to the certain position (fix it with normal tapping screws).

1) Notices for wiring

Please cut off the power of the indoor unit before installation. The power should be cut off during the whole installation process.

2) Installation instruction

◆ During assembly process, please make the panel with the reset button of G-Cloud face to the user for convenient operation. After that, the user can perform reset and other operations.

◆ Do not install G-Cloud at damp place.

◆ The installation position of G-Cloud is different for different models. For details, please install it according to user requirements and actual installation position of the model (the installation position of G-Cloud in above figure is only for reference).

4 App Instructions

4.1 App Download

Control the home appliances and track the running status via cellular network and home wireless router.

Please scan the QR code below to download GREE+.



QR Code for GREE+ Download

Compatibility:

Requires iOS 8.0/Android 4.4 or latter. The improvement of appliances would cause the change of GREE+. Please refer to the current contents and operations.

4.2 Configuring/Reset WiFi (2 Methods):

- 1) Method 1 (Temperature Controller): Under the power-on state, press “function” button on the temperature controller to switch to the WiFi function. The WiFi icon flashes, and then it enters into the WiFi function setting status. The WiFi icon flashes, and then it enters into the WiFi function setting status. The original temperature display area “888” will display the current WiFi status by default. Use the “up” and “down” buttons to select the setting content. Select “RES” and then press the “swing / OK” button to save the setting, that is, G-Cloud has been reset successfully.
- 2) Method 2 (G-cloud): Press and hold the button of G-Cloud for 8s to reset it.
Note: It needs to perform the configuration again when replacing the router, the router name and router password.

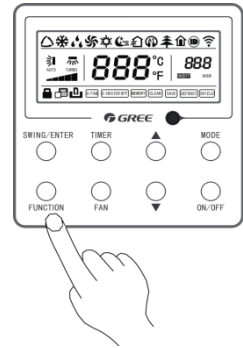



GREE ELECTRIC APPLIANCES, INC. OF ZHUHAI

Add: West Jinji Rd, Qianshan, Zhuhai, Guangdong, China, 519070

Tel: (+86-756) 8522218

Fax: (+86-756) 8669426

E-mail: gree@gree.com.cn www.gree.com



600005060696